

BLANK PANEL BP193

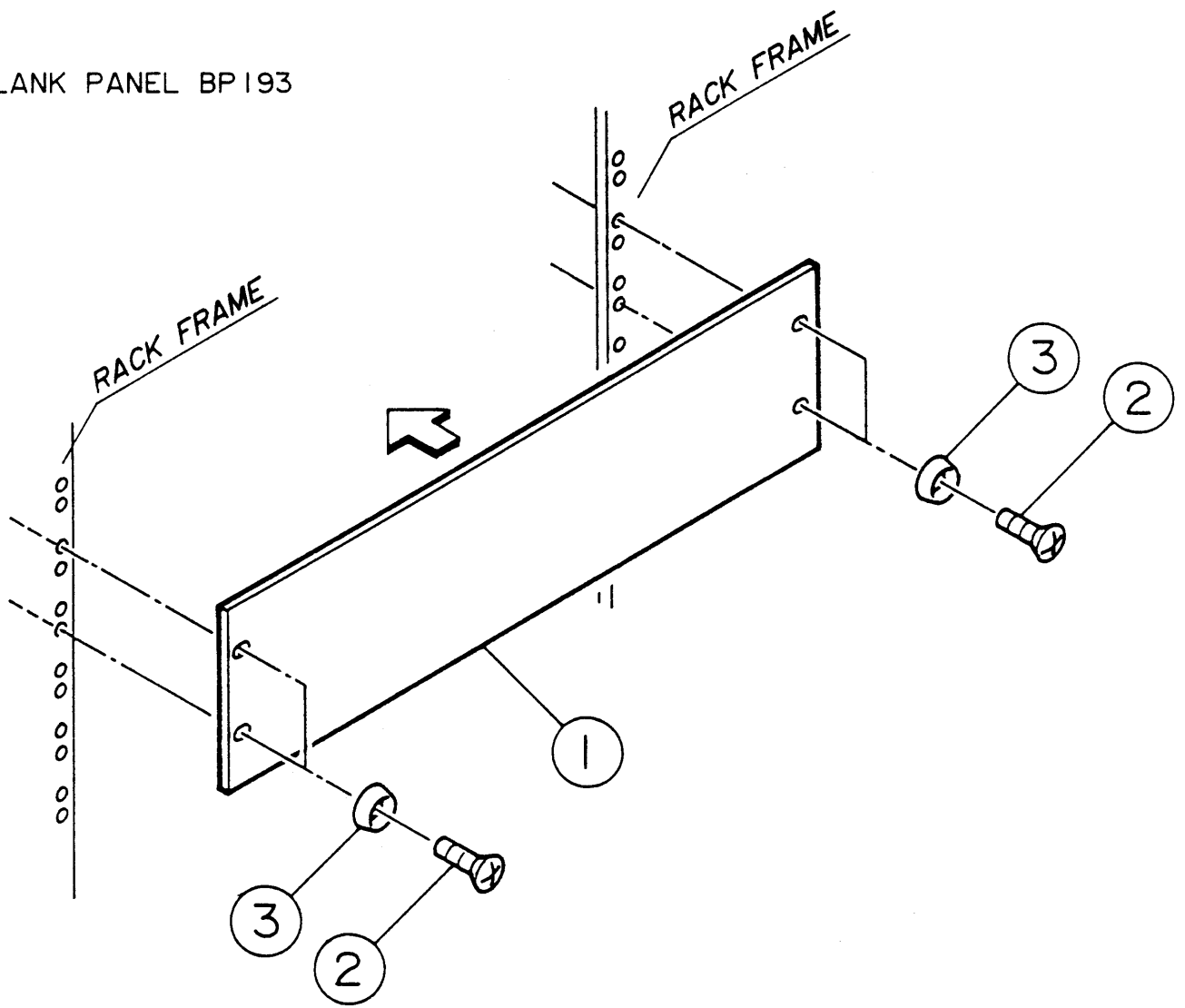

NO.	DESCRIPTION	QTY	CODE NO.
1	BLANK PANEL BP193	1	A4-906-201
2	SCREW, OVAL HEAD M5x0.8x14 B-NI	4	M2-002-091
3	FINISHING WASHER 5CW	4	M5-003-031