

Operation Manual

Electronic load booster PLZ2405WB

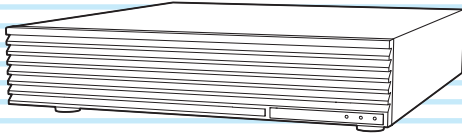

This product can be connected in parallel with a PLZ1205W electronic load to increase input current. You can connect up to four units to a single PLZ1205W. The PLZ1205W operates as a master unit and the PLZ2405WB as a slave unit.

Number of boosters	Maximum power	Maximum current
1 unit	3600 W	720 A
2 units	6000 W	1200 A
3 units	8400 W	1680 A
4 units	10800 W	2160 A

About this manual

This manual contains an overview of the PLZ2405WB electronic load booster and information about connection, specifications, and the like. For information on how to perform parallel operation, see the PLZ1205W Series Electronic Load User's Manual.

These manuals are intended for users of this product and their instructors. Explanations are given under the presumption that the reader has knowledge of power supplies.

Every effort has been made to ensure the accuracy of this manual. However, if you have any questions or find any errors or omissions, please contact your Kikusui agent or distributor.

If you find any misplaced or missing pages in the manuals, they will be replaced. If the manual gets lost or soiled, a new copy can be provided for a fee. In either case, please contact your Kikusui agent or distributor. At that time, inform your agent or distributor of the "Part No." written on the front cover of this manual.

After you have finished reading this manual, store it so that you can use it for reference at any time.

Features

- Connecting the maximum number of boosters (four) in parallel with the PLZ1205W (master unit) creates a 10.8 kW, 2160 A load. The master unit shows the total current and total power. The entire set of units connected in parallel can be used as a single load.
- Connection is easy. Only a single signal cable needs to be connected between the master unit and a booster and between each booster.
- There is no power switch. The on and off of the AC input power supply is controlled by the master unit.

Checking the Package Contents

Check that all accessories are included and that the main unit and accessories have not been damaged during transportation. If the main unit or any of the accessories are damaged or missing, contact your Kikusui agent or distributor. We recommend that you save all packing materials, in case the product needs to be transported at a later date.

Accessories

The attached power cord varies depending on the shipment destination.

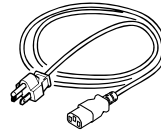

Rating: 125 V/10A
Plug: NEMA5-15
[85-AA-0004]

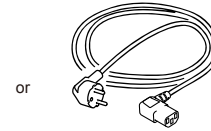

Rating: 250 V and 10A
Plug: CEE7/7
[85-AA-0005]



Rating: 250 V and 10A
Plug: GB1002
[85-10-0790]

- Power cord (1 pc., length: 2.5 m)

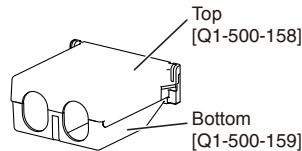

- Load input terminal cover

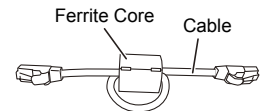

- Parallel operation signal cable kit (PC01-PLZ-5W)

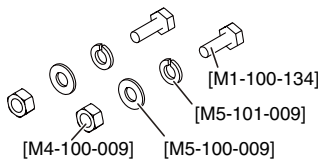

- Load input terminal screw set (2 sets)

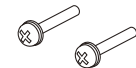

- Screws for the load input terminal cover (2 pcs.)
[M3-112-018]

- Operation manual (this manual: 1 copy)

KIKUSUI ELECTRONICS CORP.

1-1-3, Higashiyamata, Tsuzuki-ku, Yokohama,
224-0023, Japan

TEL: +81-45-593-0200 Fax: +81-45-593-7571



Website

<http://www.kikusui.co.jp/en>

The newest version of the operation manual can be downloaded from Download service of Kikusui website.

Safety Markings

For the safe use and safe maintenance of this product, the following symbols are used throughout this manual and on the product. Note the meaning of each of the symbols to ensure the safe use of the product. (Some symbols are not used depending on the product.)



Indicates that a high voltage (over 1000 V) is used here.

Touching an area marked with this symbol without taking proper precautions may cause a fatal or serious electric shock. If you must touch an area marked with this symbol, ensure that the area is safe before you do so.

DANGER

Indicates an imminently hazardous situation which, if ignored, will result in death or serious injury.



WARNING

Indicates a potentially hazardous situation which, if ignored, could result in death or serious injury.



CAUTION

Indicates a potentially hazardous situation which, if ignored, may result in only damage to the product or other property.



Indicates a prohibited act.



Indicates a warning, caution, or danger. When this symbol is marked on the product, see the relevant section in this manual.



Protective conductor terminal.



Chassis (frame) terminal.



On (power supply).



Off (power supply).



In position of a bi-stable push control.



Out position of a bi-stable push control.

⚠ Safety Precautions

The following safety precautions must be observed to avoid fire hazards, electric shock, accidents, and device failures. Keep them in mind and make sure to observe them.

Using the product in a manner that is not specified in this manual may impair the protection functions provided by the product.

Users



- This product must be used only by qualified personnel who understand the contents of this operation manual.
- If unqualified personnel are to use the product, be sure the product is handled under the supervision of qualified personnel (those who have electrical knowledge). This is to prevent the possibility of personal injury.

Purpose of use



- Never use the product for purposes other than the product's intended use.
- This product is not designed or manufactured for general home or consumer use.

Input power supply

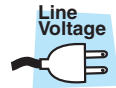

- Always use the product within the rated input line voltage range.
- Use the power cord provided to apply power. For details, see the respective page in this manual.
- This product conforms to IEC Overvoltage Category II (energy-consuming equipment that is supplied from a fixed installation).

Cover



- Some parts inside the product are hazardous. Do not remove the external cover.

Grounding

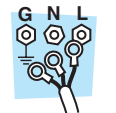

- This product conforms to IEC Safety Class I (equipment that has a protective conductor terminal). To prevent electric shock, be sure to connect the protective conductor terminal of the product to electrical ground (safety ground).

Operation



- If you notice a malfunction or abnormality in the product, stop using it immediately, and remove the power cord plug from the outlet. Make sure the product is not used until it is completely repaired.

- Do not disassemble or modify the product. If you need to modify the product, contact your Kikusui agent or distributor.

Maintenance and inspection



- To prevent electric shock, be sure to unplug the power cord before carrying out maintenance or inspection. Do not remove the external cover.
- Check periodically that there are no tears or breaks in the power cord.
- If the panel needs cleaning, gently wipe it using a soft cloth with water-diluted neutral detergent. Do not use volatile chemicals such as benzene or thinner.
- To maintain the performance and safe operation of the product, we recommend periodic maintenance, inspection, cleaning, and calibration.

Service



- Kikusui service engineers will perform internal service on the product. If the product needs adjustment or repairs, contact your Kikusui agent or distributor.

Precautions when Choosing the Installation Location

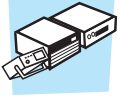

Be sure to observe the following precautions when installing the product.

- Do not use the product in a flammable environment.
Risk of explosion or fire. Do not use the product near alcohol, thinner, or other combustible materials, or in an environment containing such vapors.
- Avoid locations where the product is exposed to high temperatures or direct sunlight.
Do not install the product near a heater or in areas subject to drastic temperature changes. For the operating temperature range and storage temperature range, see the specifications in this manual.
- Avoid humid environments.
Do not install the product in high-humidity locations, such as near a boiler, humidifier, or water supply. For the operating humidity range and storage humidity range, see the specifications in this manual. Condensation may form even within the operating humidity range. If this happens, do not use the product until the condensation dries up completely.
- Be sure to use the product indoors.
This product is designed for safe indoor use.
- Do not install the product in a corrosive environment.
Do not install the product in a corrosive atmosphere or in an environment with a high level of sulfuric acid mist or other types of poisonous gas. Doing so may damage the terminals or cause the internal conductors to corrode. This can lead to malfunction, damage to the product, or fire.
- Do not install the product in a dusty location.
Dust accumulation can lead to electric shock or fire.
- Do not use the product in a poorly ventilated location.
Secure adequate space around the product so that air can circulate around it.
Allow at least 20 cm of space between the air inlet/outlet and the wall (or obstacles).
- Do not place objects on top of the product.
Placing objects (especially heavy ones) on top of the product can lead to malfunctions.
- Do not install the product on an inclined surface or in a location subject to vibrations.
The product may fall or tip over and cause damage and injury.
- Do not use the product in a location subject to strong magnetic or electric fields or in a location where the input power supply signal contains large amounts of distortion or noise.
Doing so may cause the product to malfunction.
- Use the product in an industrial environment.
Using this product in a residential area may interfere with radio and TV broadcast reception. In such case, users may need to take special measures to reduce the electromagnetic radiation.
- Do not stack three or more loads on top of each other.
You can stack loads (booster and master unit), but for safety reasons, only stack up to two units.
If you want to use two or more boosters, we recommend that you rack mount them.

Stacking three or more units is prohibited.

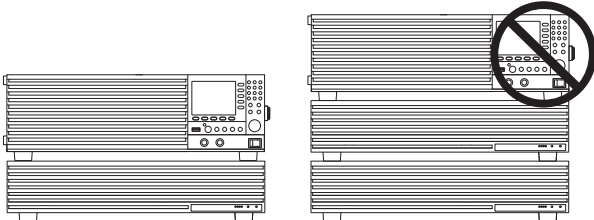

Precautions for Moving the Product



Note the following points when moving the product to the installation location or when transporting the product.

- Turn off the POWER switch.
Moving the product with the POWER switch turned on may cause electric shock or damage to the product.
- Remove all wiring.
Moving the product with the cables connected may cause wires to break or injuries due to the product falling over.
- When transporting the product, be sure to use the original packing materials.
Otherwise, damage may result from vibrations or from the product falling during transportation.
- Be sure to include this manual.

Notations Used in this Manual

- In this manual, the PLZ1205W and PLZ2405WB are sometimes referred to as a load.
- The PLZ1205W is sometimes referred to as the master unit.
- The PLZ2405WB is sometimes referred to as a booster.
- The illustrations used in this manual may differ from the actual items.
- The following markings are used in the explanations in this manual.

WARNING

Indicates a potentially hazardous situation which, if ignored, could result in death or serious injury.

CAUTION

- Indicates a potentially hazardous situation which, if ignored, may result in only damage to the product or other property.

—Note—

Indicates information that you should know.

Component Names

Front panel

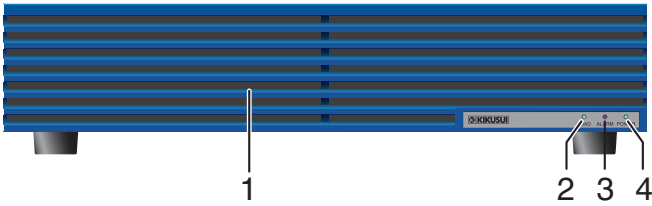

Rear panel

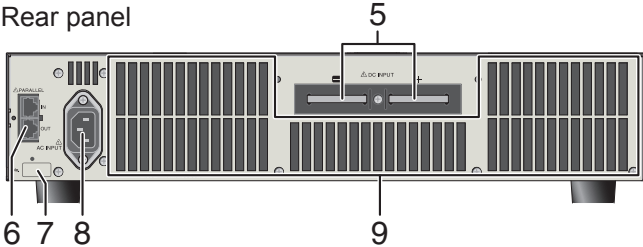

1. Air inlet for internal cooling (louver)

Air inlet for exhausting internal heat using a fan.

2. LOAD LED

Solid green: When load is on.

3. ALARM LED

Blinking red: Overheat protection activated in this product
Solid red: An alarm detected in another product connected in parallel.

4. POWER LED

Solid green: When the master unit connected in parallel is on.

5. DC INPUT (load input terminal)

Terminal for connecting the DUT.

6. PARALLEL connector

Connectors for connecting the included parallel operation signal cable to enable parallel operation. The upper connector is the IN connector, and the lower connector the OUT.

7. Serial number

8. AC INPUT connector

Power inlet.

9. Air outlet

Air outlet for exhausting internal heat using a fan.

Connecting the Master Unit

Use the included parallel operation signal cables to connect between loads. You can connect up to four boosters to a single master unit (PLZ1205W).

To prevent unstable operation, run the load cables and parallel operation signal cables as far away from each other as possible.

⚠ CAUTION

To avoid damaging the product, observe the following precautions.

- Do not connect the cables to the wrong connectors.
- Do not perform standalone operation with the parallel operation signal cable left connected.

—Note—

Do not use cables other than the included parallel operation signal cables to connect.

1 Check the following items.

- The master unit's POWER switch is turned off (○).
- The booster power cords are not connected.

2 Connect the PARALLEL connectors of the master unit and boosters using parallel operation signal cables.

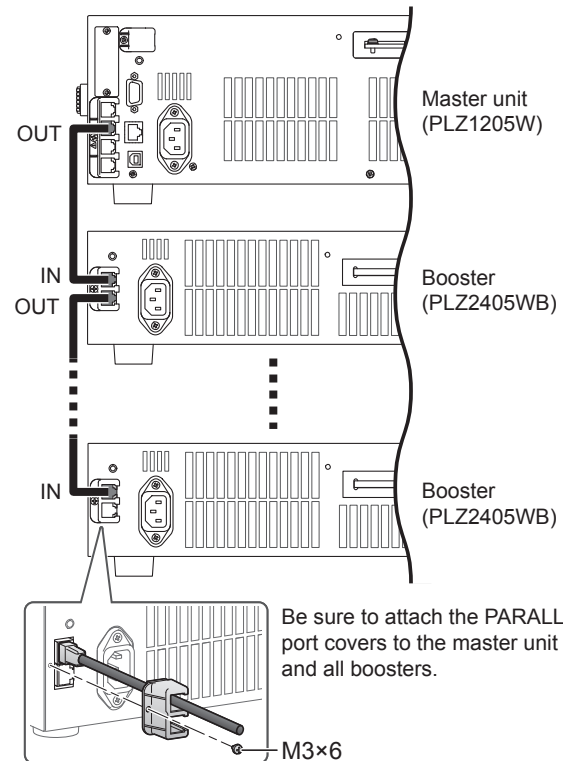

Be sure to attach the PARALLEL port covers to the master unit and all boosters.

M3×6

This completes the procedure for connecting the signal wires.

Connecting to the DUT

Connect the load and DUT using load cables. Wiring precautions and other items to be considered when connecting the DUT are the same as those when wiring the PLZ1205W. To ensure operational stability, see "Methods to Stabilize Operation" in the appendix of the PLZ1205W User's Manual.

⚠ WARNING

- Risk of fire. Use load cables whose capacity is adequate for the product's rated output current.
- Risk of electric shock. Use load cables with a voltage rating that meets or exceeds the product's isolation voltage (± 500 V).

⚠ CAUTION

Use load cables with a core diameter that is appropriate for the amount of current being used and with sturdy, flame-resistant insulation.

Selecting the load cable

If the resistance of the cables used as the load cables is large, a large voltage drop may occur when current flows through the cables. This may result in the load input terminal voltage being lower than the minimum operating voltage of this product. Referring to the table below, select a cable with a nominal cross-sectional area as great as possible.

Nominal cross-sectional area [mm ²]	AWG	(Reference cross-sectional area) [mm ²]	Allowable current ¹ [A] (Ta = 30 °C)	Kikusui-recommended current [A]
50	1/0	(53.49)	190	-
60	2/0	(67.43)	217	-
80	3/0	(85.01)	257	200
100	4/0	(107.2)	298	-
125	-	-	344	-
150	-	-	395	300
200	-	-	469	-
250	-	-	556	-
325	-	-	650	-

1. Excerpt from Japanese laws related to electrical equipment.

—Note—

A cable's temperature is determined by the resistive loss based on the current, the ambient temperature, and the cable's external thermal resistance. The above table shows the current capacity of heat-resistant vinyl cables that have a maximum allowable temperature of 60 °C when one of the cables is separated and stretched out horizontally in air in an ambient temperature of 30 °C. The current must be reduced under certain conditions, such as when vinyl cables that have a low heat resistance are used, when the ambient temperature is 30 °C or greater, or when cables are bundled together and little heat is radiated.

Connecting the DUT

The load input terminal of the master unit (PLZ1205W) is not designed to handle as large a current as the load input terminal of the booster. Separate the load cables that are connected to the DUT into those that are connected to the master unit and those that are connected to the boosters. Use load cables that are as thick and short as possible, and make the lengths and cross-sectional areas the same.

⚠ WARNING

Risk of electric shock.

- Do not touch load terminals when the output is turned on.
- Be sure to use the load input terminal cover.

⚠ CAUTION

- To avoid damaging the product, observe the following precautions. On the master unit, be sure to use the load input terminal on the rear panel. Do not connect other electronic loads to the load input terminals on the front panel.
- To avoid overheating, observe the following precaution. Attach crimping terminals to the cables, and use the supplied screws to connect the cables.

1 Check the following items.

- The master unit's POWER switch is turned off (○).
- The booster power cords are not connected.
- The DUT's output is off.

2 Connect load cables to the load input terminal on the master unit's rear panel as shown in the PLZ1205W user's manual.

3 Connect the load cables to the load input terminals on the booster using the included load input terminal screw set.

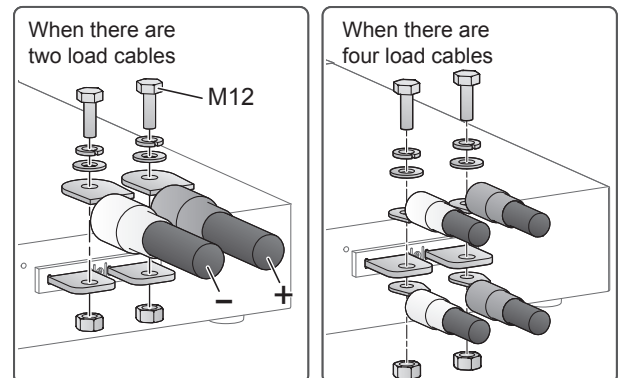

4 Place the bottom half of the load input terminal cover underneath the load input terminals.

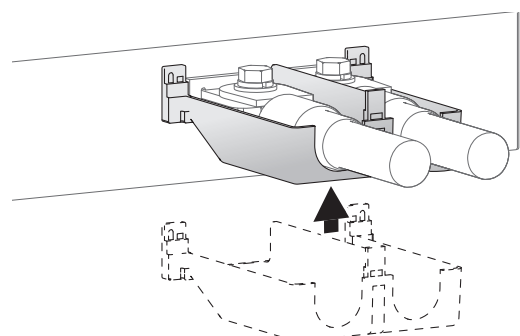

- 5** Align the top half of the load input terminal cover to the bottom half.

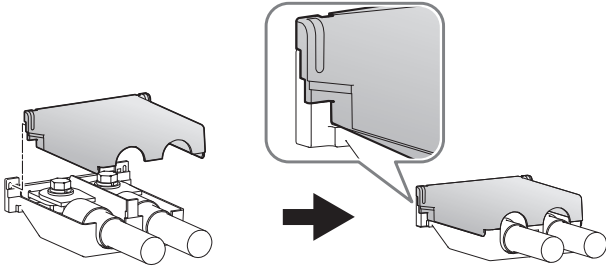

- 6** Push the load input terminal cover against the panel, and fasten it with the included load input terminal cover screws.

Make sure that the screws are securely fastened.

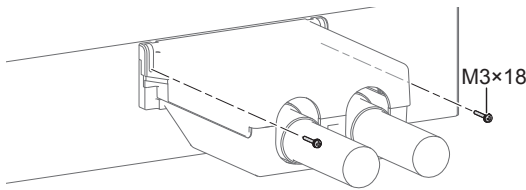

If there are several boosters, connect load cables to all of them in a similar manner.

- 7** Refer to the following figure, and connect the master unit and boosters to the DUT.

Example: Connection of two boosters.

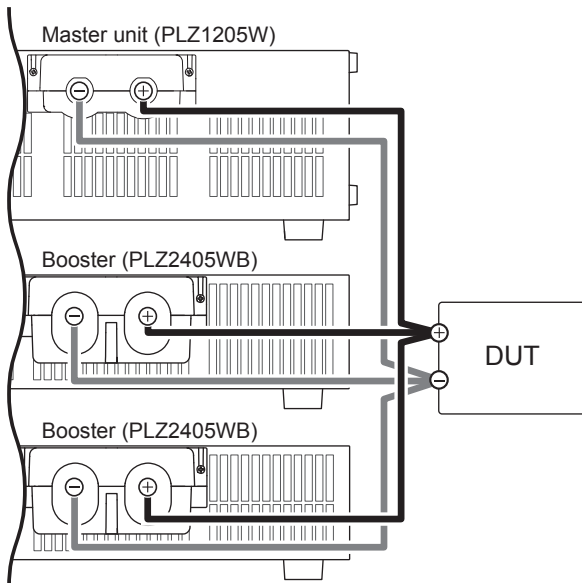

This completes the procedure for connecting the load cables.

Connecting the Power Cord

This product conforms to IEC Overvoltage Category II (energy-consuming equipment that is supplied from a fixed installation).

! WARNING

Risk of electric shock.

- This product conforms to IEC Safety Class I (equipment that has a protective conductor terminal). Be sure to earth ground the product.
- Connect the protective conductor terminal to earth ground.

Use the included power cord to connect to the AC line.

If the supplied power cord cannot be used because the rated voltage or the plug shape is incompatible, have a qualified engineer replace it with an appropriate power cord that is 3 m or less in length. If obtaining a power cord is difficult, contact your Kikusui agent or distributor.

The power cord with a plug can be used to disconnect the product from the AC power line in an emergency. Connect the plug to an easily accessible power outlet so that the plug can be removed from the outlet at any time. Be sure to provide adequate clearance around the power outlet.

Do not use the supplied power cord with other instruments.

This product does not have a power switch. The power is synchronized to the on/off state of the master unit.

- 1** Check that the AC power line meets the nominal input rating of the product.

The product can receive a nominal line voltage in the range of 100 Vac to 240 Vac at 50 Hz or 60 Hz.

- 2** Connect the power cord to the AC INPUT connector on the rear panel.

- 3** Connect the power cord plug to a properly grounded outlet.

Performing Parallel Operation

During parallel operation, the slew rate and response speed settings on the master unit are used.

If large voltage drops occur because of increased wiring inductance or if oscillations occur due to instability of the product caused by current phase lag, reduce the response speed to ensure stable operation.

Turning the power on and off

■ Turning the power on

Turn the master unit's POWER switch on. This will also turn the boosters on.

Set the operation mode and configure the settings on the master unit, and turn the load on.

■ Turning the power off

Turn the master unit's POWER switch off. This will also turn the boosters off.

Ending parallel operation

To set the master unit back to independent operation, turn the master unit off, and then remove the parallel operation signal cables.

CAUTION

To avoid damaging the product, observe the following precautions. Do not perform standalone operation with the parallel operation signal cable left connected.

Calibration

The product is calibrated before shipment. To maintain long-term performance, we recommend periodic calibration.

To have your PLZ2405WB calibrated, contact your Kikusui agent or distributor.

Rack Mount Brackets

The following brackets are available as options.

For EIA inch racks	For JIS millimeter racks
KRB2-TOS	KRB100-TOS

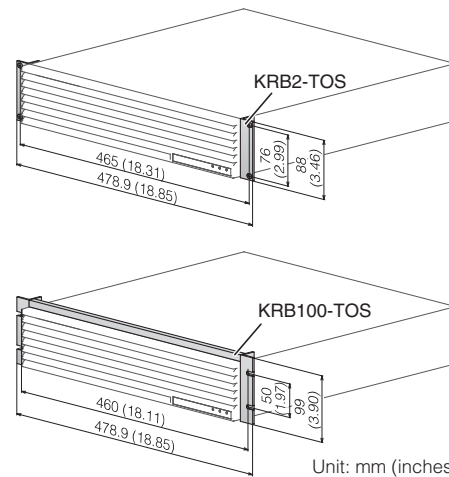

When mounting to a rack, to support the main unit, attach an angle support to it that is appropriate for the rack.

For information about options, contact your Kikusui agent or distributor.

Specifications

Electrical specifications

Unless specified otherwise, the specifications are for the following settings and conditions.

- Warm-up time: 30 minutes (with current flowing)
- Ambient temperature 23°C±5°C
- TYP: These are typical values that are representative of situations where the product operates in an environment with an ambient temperature of 23°C. These values do not guarantee the performance of the product.
- set: Indicates a setting.
- range: Indicates the rated value of each range.
- reading: Indicates a reading.

Ratings

Operating voltage	1 Vdc to 150 Vdc
Power	2400 W
Current	480 A

Current range

H range	0 A to 480 A
M range	0 A to 48 A
L range	0 A to 4.8 A

Setting accuracy

CC mode	H range	±(0.4 % of set + 0.8 % of range)
	M range	±(0.4 % of set + 0.8 % of range)
	L range	±(0.4 % of set + 5 % of range)
CR mode	H range	±(0.5 % of set + 1.5 % of range)
	M range	±(0.5 % of set + 1.5 % of range)
	L range	±(0.5 % of set + 5 % of range)
CV mode		±(0.2 % of set + 0.2 % of range)
CP mode ¹	H range	±(2 % of range + 0.4 % current range × Vin)
	M range	±(2 % of range + 0.4 % current range × Vin)
	L range	±(2 % of range + 2.5 % current range × Vin)

1. Vin: Load input terminal voltage or sensing terminal voltage.

Measurement accuracy

Voltmeter accuracy	±(0.1 % of reading + 0.1 % of range)	
Ammeter accuracy	H range	±(0.4 % of reading + 0.8 % of range)
	M range	±(0.4 % of reading + 0.8 % of range)
L range	±(0.4 % of reading + 5 % of range)	

Protection functions

Protection functions other than those below are detected and activated on the PLZ1205W. For details, see the PLZ-5W user's manual.

Over temperature protection (OTP)	Turns off the load when the heatsink temperature reaches 100 °C
-----------------------------------	---

General specifications

Input power supply voltage range	100 Vac to 240 Vac (90 Vac to 250 Vac) single-phase, continuous	
Input frequency range	47 Hz to 63 Hz	
Power consumption	95 VAmax	
Inrush current (peak value)	45 Apeak	
Environment	Operating temperature range	0 °C to 40 °C (32 °F to 104 °F)
	Operating humidity range	20 %rh to 85 %rh (no condensation)
	Storage temperature range	-20 °C to 70 °C (-4 °F to 158 °F)
	Storage humidity range:	90 %rh or less (no condensation)
	Installation location	Indoor use, altitude of up to 2000 m, overvoltage category II
Isolation voltage	±500 V	

Insulation resistance	Between primary and input terminals, between primary and chassis, between input terminals and chassis	500 Vdc 30 MΩ or greater (at 70 %rh humidity or less)
Withstanding voltage	Between primary and input terminals	No abnormalities at 1500 Vac for 1 minute
	Between primary and chassis	No abnormalities at 1500 Vac for 1 minute
	Between input terminals and chassis	No abnormalities at 750 Vdc for 1 minute
External dimensions		See "Outline drawing".
Weight		Approx. 15 kg (33.07 lb)
Accessories		See (p. 1).
Electromagnetic compatibility (EMC) ^{1 2}		Complies with the requirements of the following directive and standards. EMC Directive 2014/30/EU EN 61326-1 (Class A ³) EN 55011 (Class A ³ , Group 1 ⁴) EN 61000-3-2 EN 61000-3-3 Applicable under the following conditions The maximum length of all cabling and wiring connected to the product must be less than 3 m.
Safety ¹		Complies with the requirements of the following directive and standards. Low Voltage Directive 2014/35/EU ² EN 61010-1 (Class I ⁵ , Pollution Degree 2 ⁶)

1. Does not apply to specially made or modified products.
2. Limited to products that have the CE mark on their panel.
3. This is a Class A equipment. This product is intended for use in an industrial environment. This product may cause interference if used in residential areas. Such use must be avoided unless the user takes special measures to reduce electromagnetic emissions to prevent interference to the reception of radio and television broadcasts.
4. This is a Group 1 equipment. This product does not generate and/or use intentionally radio-frequency energy, in the form of electromagnetic radiation, inductive and/or capacitive coupling, for the treatment of material or inspection/analysis purpose.
5. This is a Class I equipment. Be sure to ground the this product protective conductor terminal. The safety of this product is only guaranteed when the product is properly grounded.
6. Pollution is addition of foreign matter (solid, liquid or gaseous) that may produce a reduction of dielectric strength or surface resistivity. Pollution Degree 2 assumes that only non-conductive pollution will occur except for an occasional temporary conductivity caused by condensation.

Outline drawing

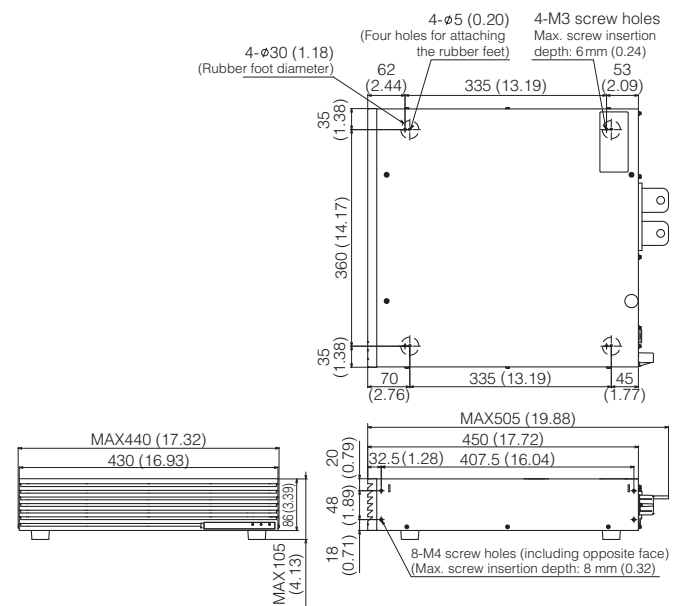

Unit: mm (inches)



环境保护使用期限
Environment-friendly Use Period

该标记为适用于在中华人民共和国销售的电子信息产品的环境保护使用期限。

只要遵守有关该产品的安全及使用注意事项，从制造年月起计算，在该年度内，就不会对环境污染、人身、财产产生重大的影响。

产品的废弃请遵守有关规定。

产品的制造年月可以在以下网址中确认。

<http://www.kikusui.co.jp/pi/>

有毒有害物质或元素名称及含有标示

Name of hazardous materials and symbol of element in the equipment and quantity

部件名称	有毒有害物质或元素					
	铅 Pb	汞 Hg	镉 Cd	六价铬 Cr(VI)	多溴联苯 PBB	多溴二苯醚 PBDE
印刷电路板组装品	×	○	○	○	○	○
内部接线	○	○	○	○	○	○
外壳	×	○	○	○	○	○
底盘组装品 (含变压器)	×	○	○	○	○	○
辅助设备	○	○	○	○	○	○

本表格依据 SJ/T 11364 的规定编制。

- ：该部件所有均质材料的有毒有害物质的含量不超过 GB/T 26572 标准所规定的极限值要求。
- ×
- ×：该部件至少有一种均质材料的有毒有害物质的含量超过 GB/T 26572 标准所规定的极限值要求。